

XVR301-Q Series



Key Features

- Support H.265/H.264 video formats
- Support audio over coaxial cable
- Support TVI, AHD, CVI, CVBS, IP cameras with adaptive access
- 4/8-channel BNC input
- Support 1-ch HDMI output, 1-ch VGA output at up to 1920*1080
- Long transmission distance over coaxial cable

Specifications

Model	XVR301-04Q	XVR301-08Q
Video/Audio Input		
Analog Video Input	4-ch, BNC	8-ch, BNC
IP Video Input	2-ch(only IP up to 6ch), each channel up to 4K	4-ch(only IP up to 12ch), each channel up to 4K
Supported Analog Camera Types	Support AHD input: 8MP@15fps(channel1) 5MP@20fps 4MP@30fps 3MP@30fps(channel1) 1080P@30fps 720P@60fps Support TVI input: 8MP@15fps(channel1) 5MP@20fps 4MP@30fps 3MP@20fps (channel1) 1080P@30fps	Support AHD input: 8MP@15fps(channel1-channel2) 5MP@20fps 4MP@30fps 3MP@30fps(channel1-channel2) 1080P@30fps 720P@60fps Support TVI input: 8MP@15fps(channel1-channel2) 5MP@20fps 4MP@30fps 3MP@20fps(channel1-channel2) 1080P@30fps

	720P@60fps Support CVI input: 8MP@15fps(channel1) 5MP@20fps 4MP@30fps 1080P@30fps 720P@30fps Support CVBS input	720P@60fps Support CVI input: 8MP@15fps(channel1-channel2) 5MP@20fps 4MP@30fps 1080P@30fps 720P@30fps Support CVBS input
Audio Input	1-ch, RCA	
Two-way Audio	1-ch, RCA	
Network		
Incoming Bandwidth	48Mbps	56Mbps
Outgoing Bandwidth	60Mbps	64Mbps
Remote Users	128	
Protocols	TCP/IP, P2P, UPnP, NTP, DHCP, PPPoE	
Video/Audio Output		
CVBS Output	1-ch, BNC	
VGA Output	1920x1080p/60Hz, 1920x1080p/50Hz, 1600x1200/60Hz, 1280x1024/60Hz, 1280x720/60Hz, 1024x768/60Hz	
HDMI Output	1920x1080p/60Hz, 1920x1080p/50Hz, 1600x1200/60Hz, 1280x1024/60Hz, 1280x720/60Hz, 1024x768/60Hz	
Audio Output	1-ch, RCA	
Synchronous Playback	4-ch	8-ch
Encoding		
Recording Resolution	8MP Lite/5MP Lite/4MP Lite /3MP/1080P/960P/720P/960H/4CIF/CIF	
Recording Frame Rate	Main stream: 8MP Lite@8fps(channel1) 5MP Lite@12fps 4MP Lite@15fps 3MP@15fps(channel1) 2MP@15fps 720P@30fps Sub stream: D1@30fps(Max)	Main stream: 8MP Lite@8fps(channel1-channel2) 5MP Lite@12fps 4MP Lite@15fps 3MP@15fps(channel1-channel2) 2MP@15fps 720P@30fps Sub stream: D1@30fps(Max)
Hard Disk		
SATA	1 SATA interface	

Capacity	Up to 6TB for each HDD
External Interface	
Network Interface	1 RJ45 10M/100M self-adaptive Ethernet Interface
USB Interface	Rear panel: 2 x USB2.0
Serial Interface	1 x RS485
General	
Power Supply	12V DC Power Consumption: ≤ 8 W(without HDD)
Working Environment	-10°C ~ + 55°C (+14°F ~ +131°F), Humidity ≤ 90% RH(non-condensing)
Dimensions(W×D×H)	260mm ×240mm× 46mm (10.2" × 9.4"×1.8")
Weight (without HDD)	≤1.1 Kg (4.19lb)

Dimensions

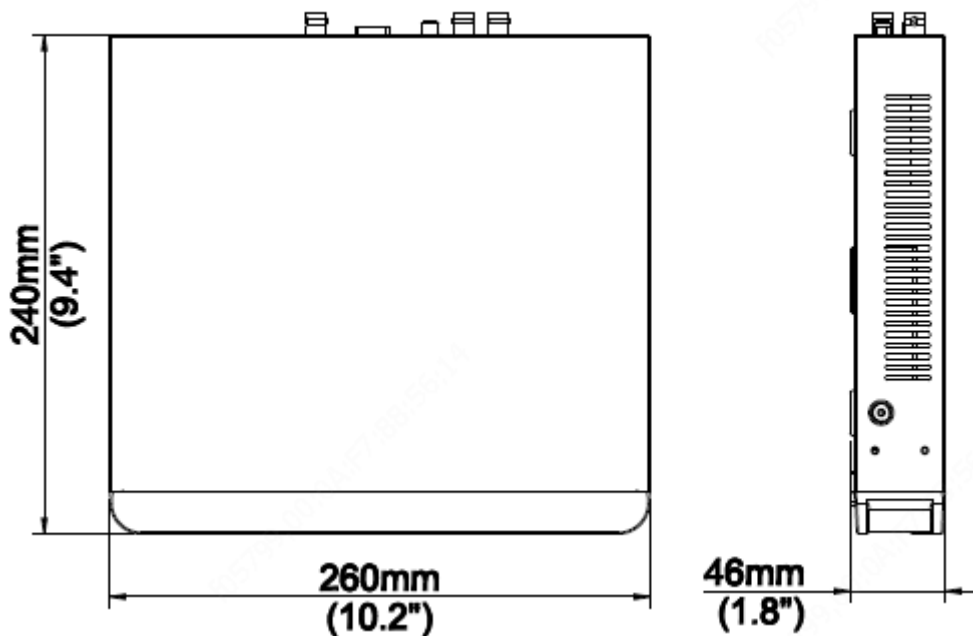

Rear Panel

Take XVR301-08Q for example

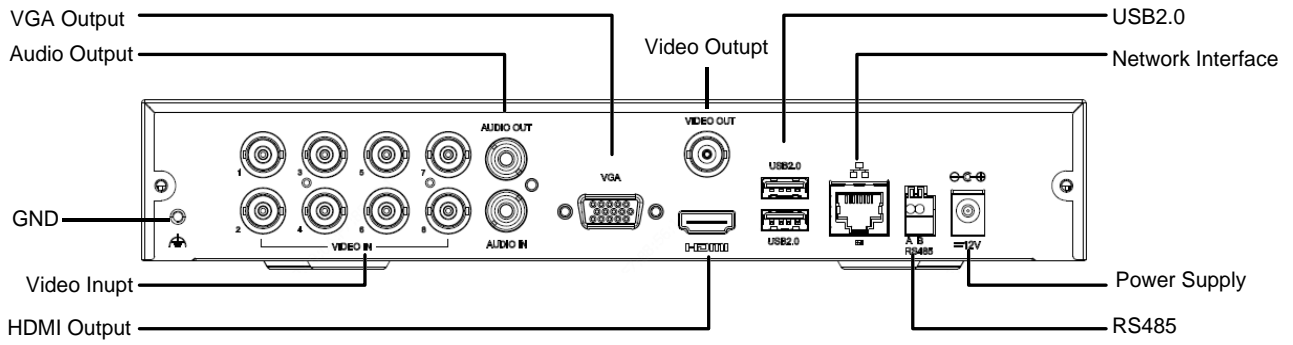

Zhejiang Uniview Technologies Co., Ltd.

Building No.10, Wanlun Science Park, Jiangling Road 88, Binjiang District, Hangzhou, Zhejiang, China

Email: overseasbusiness@uniview.com; globalsupport@uniview.com

<http://www.uniview.com>

©2020 Zhejiang Uniview Technologies Co., Ltd. All rights reserved.

* Product specifications and availability are subject to change without notice.